



ETA-Danmark A/S
Göteborg Plads 1
DK-2150 Nordhavn
Tel. +45 72 24 59 00
Internet
www.etadanmark.dk

Authorised and notified according
to Article 29 of the Regulation
(EU)
No 305/2011 of the European
Parliament and of the Council of 9
March 2011



European Technical Assessment ETA-20/1316 of 2021/01/01

I General Part

Technical Assessment Body issuing the ETA and designated according to Article 29 of the Regulation (EU) No 305/2011: ETA-Danmark A/S

Trade name of the construction product:

Nullifire FR230

Product family to which the above construction product belongs:

Fire Stopping and Sealing Product:
• Penetration Seals

Manufacturer:

Tremco CPG UK Limited
Torrington Avenue
Coventry
CV4 9TJ
United Kingdom

Manufacturing plant:

H/001

This European Technical Assessment contains:

24 pages including 2 annexes which form an integral part of the document

This European Technical Assessment is issued in accordance with Regulation (EU) No 305/2011, on the basis of:

EAD 350454-00-1104 for Fire stopping and fire sealing products - Penetration seals, September 2017

This version replaces:

-

Translations of this European Technical Assessment in other languages shall fully correspond to the original issued document and should be identified as such.

Communication of this European Technical Assessment, including transmission by electronic means, shall be in full. However, partial reproduction may be made, with the written consent of the issuing Technical Assessment Body. Any partial reproduction has to be identified as such.

I. SPECIFIC PARTS OF THE EUROPEAN TECHNICAL ASSESSMENT

1 Technical description of the product

- 1) Nullifire FR230 is a gypsum based mortar used to reinstate the fire resistance performance of wall and floor constructions where they have been provided with apertures for the penetration of single or multiple services.
- 2) The Nullifire FR230 is supplied as a dry powder in a bag, and is mixed with water to the required ratio prior to installation.
- 3) Nullifire FR230 when mixed, is poured onto a 50mm thick stone wool, mineral fibre board referenced Nullifire FB750 shutterbatt (140kg/m³).
- 4) The applicant has submitted a written declaration that Nullifire FR230 does not contain substances which have to be classified as dangerous according to Directive 67/548/EEC and Regulation (EC) No 1272/2008 and listed in the "Indicative list on dangerous substances" of the EGDS - taking into account the installation conditions of the construction product and the release scenarios resulting from there.

In addition to the specific clauses relating to dangerous substances contained in this European technical Assessment, there may be other requirements applicable to the products falling within its scope (e.g. transposed European legislation and national laws, regulations and administrative provisions). In order to meet the provisions of the Construction Products Regulation, these requirements need also to be complied with, when and where they apply.

2 Specification of the intended uses of the product in accordance with the applicable European Assessment Document: EAD 350454-00-1104

Detailed information and data is given in Annex A.

- 1) The intended use of Nullifire FR230 is to reinstate the fire resistance performance of rigid wall and floor constructions where they are penetrated by various cables, metal pipes and plastic pipes.
- 2) The specific elements of construction that the system Nullifire FR230 may be used to provide a penetration seal in, are as follows:
 - a. Rigid floors: The floor must have a minimum thickness of 150 mm and comprise aerated concrete or concrete with a minimum density of 650 kg/m³.
 - b. Rigid walls: The wall must have a minimum thickness of 150 mm and comprise concrete, aerated concrete or masonry, with a minimum density of 650 kg/m³.

The supporting construction must be classified in accordance with EN 13501-2 for the required fire resistance period.

- 3) The System Nullifire FR230 may be used to provide a penetration seal with cables, cable trays, metallic pipes with insulation and plastic pipes (for details see Annex A).
- 4) The total amount of cross sections of services (including insulation) shall not exceed 60% of the penetration area.
- 5) The system Nullifire FR230 may be used to seal apertures in the separating element up to 1100mm by 1100 mm in a floor, and 1200mm by 1200mm in a wall. The minimum permitted separation between adjacent seals/apertures is 200mm. Services should be a minimum of 100mm from seal edges. Services

within the system Nullifire FR230 seal do not require a minimum separation, except pipes which should be a minimum of 100 mm from other services in the aperture.

- 6) Services in floors shall be supported at 300mm from the top face. Services in walls shall be supported at 300mm from both faces of the wall.
- 7) The provisions made in this European Technical Assessment are based on an assumed working life of the Nullifire FR230 of 10 years, provided that the conditions laid down in the product datasheet for the packaging/transport/ storage/installation/use/repair are met. The indications given on the working life cannot be interpreted as a guarantee given by the producer or the Technical Assessment Body, but are to be regarded only as a means for choosing the right products in relation to the expected economically reasonable working life of the works.
- 8) Type Z₂: Intended for uses in internal conditions with humidity lower than 85 % RH excluding temperatures below 0°C, without exposure to rain or UV.

3 Performance of the product and references to the methods used for its assessment

Product-type: Mortar		Intended use: Penetration Seal
	Essential characteristic	Product Performance
BWR 2 Safety in case of fire		
	Reaction to fire	Class A1
	Resistance to fire	Annex A
BWR 3 Hygiene, health and environment		
	Air permeability	No performance assessed
	Water permeability	No performance assessed
	Content, emission and/or release of dangerous substances	Declaration of manufacturer
BWR 4 Safety in use		
	Mechanical resistance and stability	(See Annex B)
	Resistance to impact/movement	
	Adhesion	
	Durability	Z ₂
BWR 5 Protection against noise		
	Airborne sound insulation	No performance assessed
BWR 6 Energy economy and heat retention		
	Thermal properties	No performance assessed
	Water vapour permeability	No performance assessed

4 ASSESSMENT AND VERIFICATION OF CONSTANCY OF PERFORMANCE (HEREINAFTER AVCP) SYSTEM APPLIED, WITH REFERENCE TO ITS LEGAL BASE

According to the decision 1999/454/EC – Commission Decision of date 22nd June 1999 on the procedure for attesting the conformity of construction products pursuant to Article 20(2) of Council Directive 89/106/EEC as regards fire stopping, fire sealing and fire protective products, published in the Official Journal of the European Union (OJEU) L178/52 of 14/07/1999, see <http://eur-lex.europa.eu/JOIndex.do> of the European Commission¹, as amended, the system(s) of assessment and verification of constancy of performance (see Annex V to Regulation (EU) No 305/2011) given in the following table(s) applies (apply).

Product(s)	Intended use(s)	Level(s) or class(es)	System(s)
Fire stopping and Fire Sealing Products	For fire compartmentation and/or fire protection or fire performance	Any	1

5 Technical details necessary for the implementation of the AVCP system, as provided for in the applicable EAD

Technical details necessary for the implementation of the AVCP system are laid down in the control plan deposited at ETA-Danmark A/S prior to CE marking

Issued in Copenhagen on 2021-01-01 by

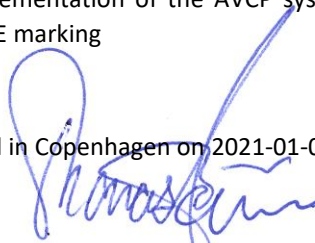

Thomas Bruun

Managing Director, ETA-Danmark

¹ Official Journal of the European Communities L178/52 of 14/7/1999

ANNEX A – Resistance to Fire Classification – Nullifire FR230

A.1 Rigid floor constructions with minimum thickness 150 mm

A.1.1 Cable penetration seal with 100 mm thick Nullifire FR230 incorporating a ‘Batt box’ and Nullifire FB750 shutterbatt backing

Penetration Seal: Cables penetrating through a rigid floor construction. 100 mm of Nullifire FR230 batt installed onto a 50 mm Nullifire FB750 shutterbatt to form a 150 mm overall seal depth. A ‘batt box’ 150 mm deep is installed atop the Nullifire FR230 seal, comprising a lining 50 mm thick Nullifire FB750 infilled with stone wool mineral fibre 64 kg/m³ coated on both faces with 3 mm Nullifire FS702. Maximum seal size of 800 x 600 mm.

Construction details:

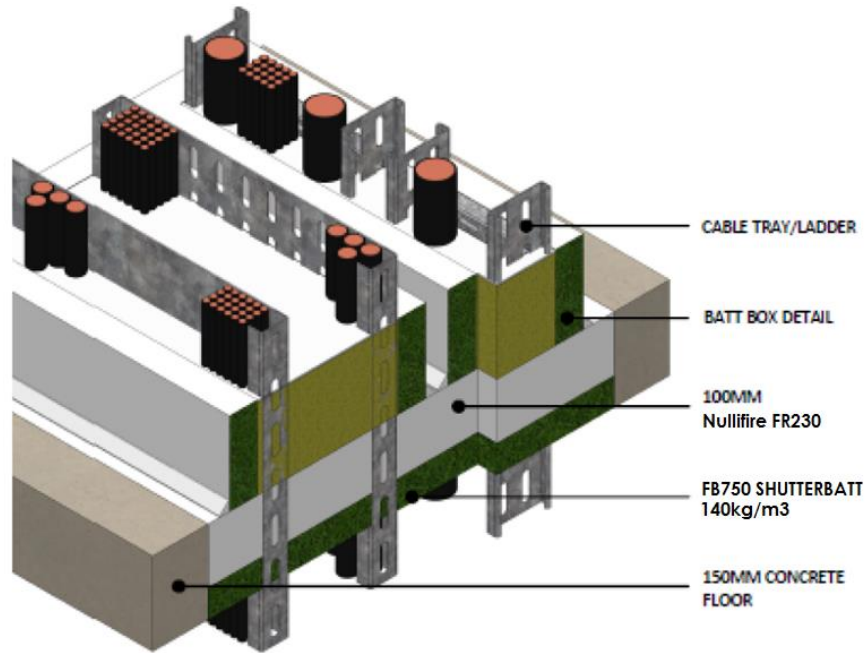

A.1.1.1 100 mm with ‘Batt Box’ penetration seal with cables

Services	Classification
Electrical cables up to 21 mm \varnothing (single, bundled and on steel trays/ladders up to 500 mm wide)	EI 240
Telecom cable up to 21mm \varnothing in tied bundles up to 100mm \varnothing	
Electrical cables 22 to 80 mm \varnothing (single, bundled and on steel trays/ladders up to 500 mm wide)	E 240, EI 120
Unsheathed wires up to 24 mm diameter	

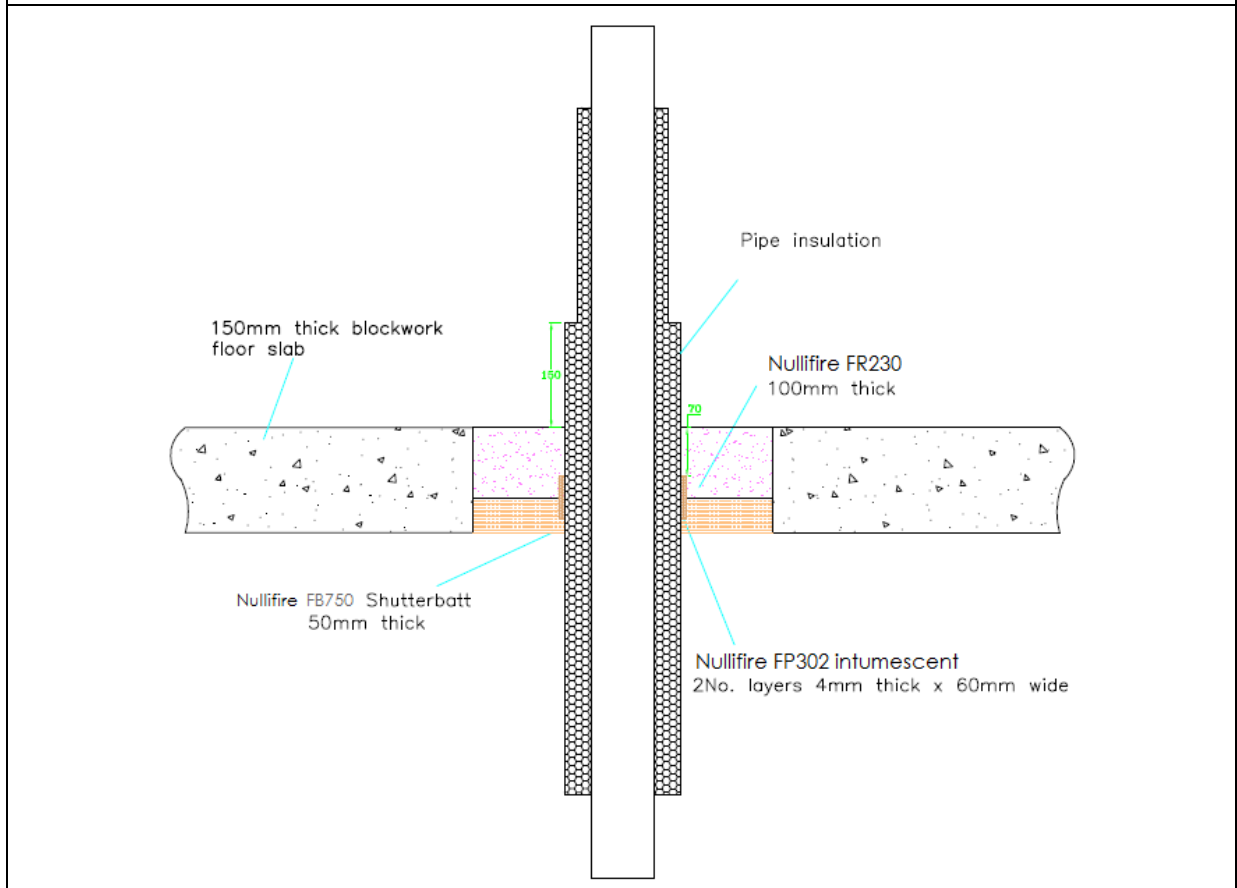
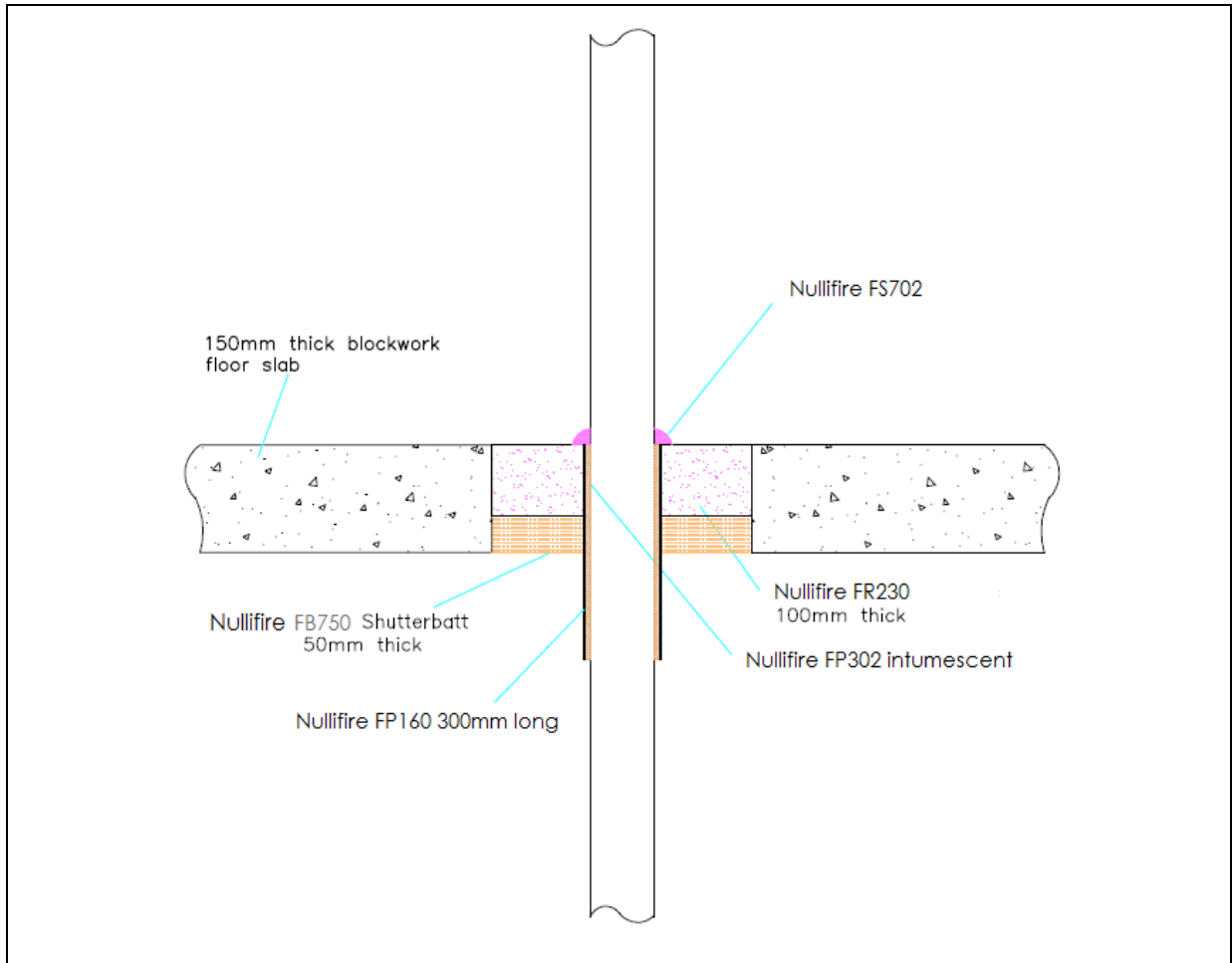

A.1.2.1

Services	Aperture in seal mm	Aperture lining	Aperture fill mm	Nullifire FP302 wrap size mm	Classification
PVC-u EN1329 BS4514 pipe 82 mm \varnothing / 3.2 mm wall	98 \varnothing	N/A		2 rows of 2 layers of 60 x 4 capped with 10x10 Nullifire FS702	EI 240 U/C
PVC-u EN 1329 pipe 82 mm \varnothing / 2.0 mm wall					
PVC-u EN 1329 pipe 110 mm \varnothing / 3.2 mm wall	134 \varnothing			2 rows of 3 layers of 60 x 4 capped with 16x16 Nullifire FS702	
PVC-u EN1329 BS4514 pipe 160 mm \varnothing / 3.2 mm wall	192 \varnothing			2 rows of 4 layers of 60 x 4 capped with 16x16 Nullifire FS702	
PPR DIN8077/8078 pipe 90 mm \varnothing / 8.2 mm wall	120 \varnothing	Nullifire FP160 0.7mm thick, 300 mm long, flush to top edge	100 deep Nullifire FR230 backed by 50 Nullifire FB750 Shutterbatt	3 layers of 300 x 4 capped with 20x20 Nullifire FS702	EI 240 C/U
HDPE pipe 82 mm \varnothing / 4.2 mm wall				2 layers of 300 x 4 capped with 20x20 Nullifire FS702	
PVC-u EN 1329 pipe 82 mm \varnothing / 3.2 mm wall				2 layers of 300 x 4 capped with 15x15 Nullifire FS702	
PVC-u EN1329 pipe 110 mm \varnothing / 3.2 mm wall	140 \varnothing			3 layers of 300 x 4 capped with 15x15 Nullifire FS702	
muPVC EN 1566 pipe 55 mm \varnothing / 2.0 mm wall	90 \varnothing			1 layers of 300 x 4 capped with 15x15 Nullifire FS702	
PVC-u EN 1329 pipe 160 mm \varnothing / 3.2 mm wall	300 \varnothing			4 layers of 300 x 4 capped with 15x15 Nullifire FS702	

A.1.2.2

Services	Aperture in seal mm	Aperture lining	Aperture fill mm	Nullifire FP302 wrap size mm	Classification
Steel pipe 55 mm \varnothing / 4.0-14.2 mm wall, insulated with 38mm thick Armaflex reducing to 19mm thick 150mm above fire seal	131 \varnothing	N/A	100 deep Nullifire FR230 backed by 50 Nullifire FB750 Shutterbatt	2 layers of 60 x 4	EI 180 C/U
Steel pipe 160 mm \varnothing / 5.0-14.2 mm wall, insulated with 50mm thick foil faced Isover glass fibre	260 \varnothing				EI 60 C/U

U/C = Uncapped/Capped, C/C (capped/capped) is also covered. C/U = Capped/Uncapped, U/C = (Uncapped/Capped) and C/C = (capped/capped) are also covered

A.1.3 Metallic pipe penetration, seal with 100 mm thick Nullifire FR230 comprising 50mm thick Nullifire FB750 in a 150 mm thick rigid floor construction.

Penetration Seal: Metallic pipes with Paroc Icerock Ductwrap 40 mm thick butted up to the fire seal on the unexposed face, fitted at any position within the aperture (min. 60 mm to edge of seal and between services), seal fitted flush to the upper surface of the floor. Maximum Nullifire FR230 seal size 1100 x 1100 mm.

Construction details:

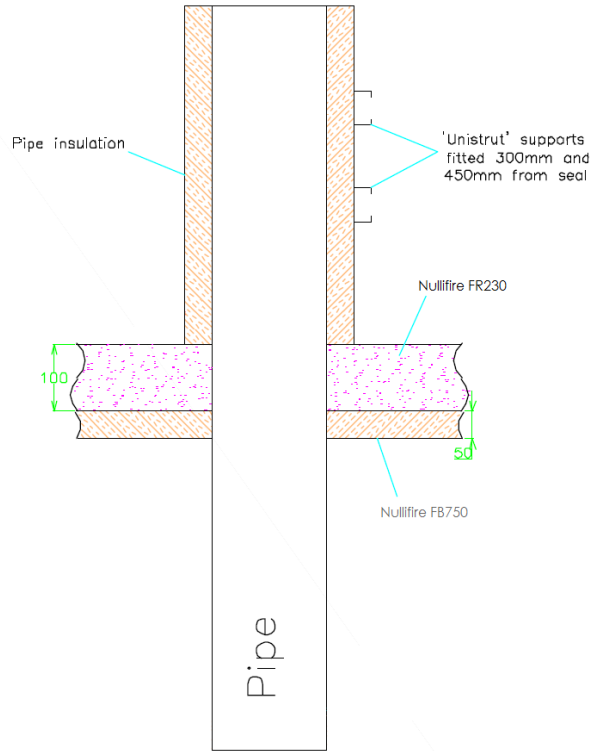

A.1.3.1

Services	Aperture in seal mm	Aperture fill mm	Nullifire FP302 wrap size mm	Classification
Steel pipe 170 mm \varnothing / 7.0-14.2 mm wall, insulated with 40mm thick Paroc Icerock Ductwrap	170 \varnothing	100 deep Nullifire FR230	N/A	E 240, EI 90 C/U
Steel pipe 150 mm \varnothing / 3.0-14.2 mm wall, insulated with 40mm thick Paroc Icerock Ductwrap	150 \varnothing			E 240, EI 60 C/U
Copper or steel pipe 108 mm \varnothing / 1.5-14.2 mm wall, insulated with 40mm thick Paroc Icerock Ductwrap	108 \varnothing			E 240, EI 45 C/U
Steel pipe 40 mm \varnothing / 1.5-14.2 mm wall, insulated with 40mm thick Paroc Icerock Ductwrap	40 \varnothing			EI 240 C/U

C/U = Capped/Uncapped, U/C = (Uncapped/Capped) and C/C = (capped/capped) are also covered

A.1.4 Metallic pipe penetration, seal with 100 mm thick Nullifire FR230 comprising 50mm thick Nullifire FB750 in a 150 mm thick rigid floor construction.

Penetration Seal: Metallic pipes with 2no. layers Beta Plus Phenolic foam 60 mm thick continuous, sustained insulation (CS), fitted at any position within the aperture (min. 60 mm to edge of seal and between services), seal fitted flush to the upper surface of the floor. Maximum Nullifire FR230 seal size 1100 x 1100 mm.

Construction details:

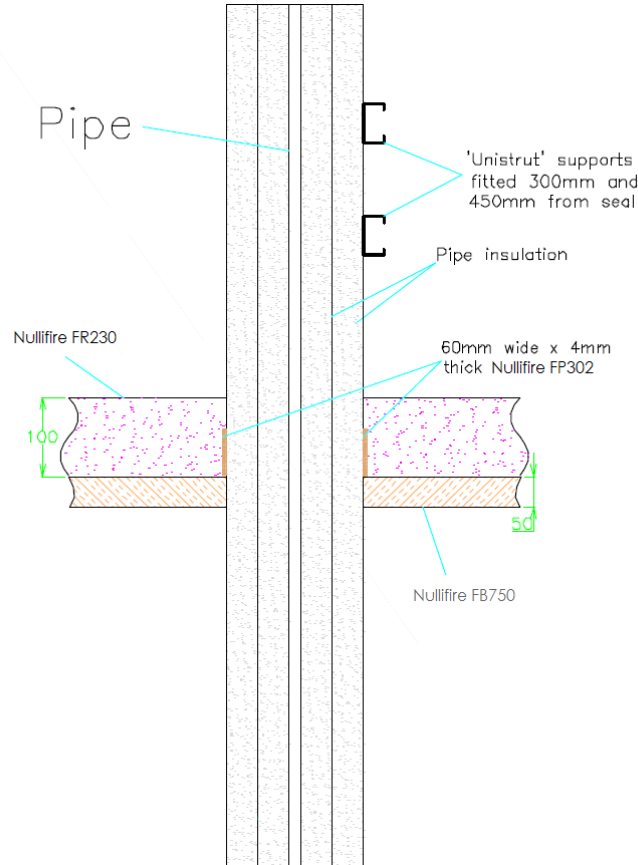

A.1.4.1

Services	Aperture in seal mm	Aperture fill mm	Nullifire FP302 wrap size mm	Classification
Copper or steel pipe 15 mm \varnothing / 0.7-14.2 mm wall, insulated with 2no. layers Beta Plus Phenolic foam 60 mm thick	135 \varnothing	100 deep Nullifire FR230	1 layer of 60 x 4 fitted above the Nullifire FB750 shutterbatt in the Nullifire FR230 around the pipe insulation	EI 240 C/U

C/U = Capped/Uncapped, U/C = (Uncapped/Capped) and C/C = (capped/capped) are also covered

A.1.5 Metallic pipe penetration, seal with 100 mm thick Nullifire FR230 comprising 50mm thick Nullifire FB750 in a 150 mm thick rigid floor construction.

Penetration Seal: Metallic pipes with 2no. layers foil faced 48kg/m³ glass mineral wool 60 mm thick continuous, sustained insulation (CS), fitted at any position within the aperture (min. 60 mm to edge of seal and between services), seal fitted flush to the upper surface of the floor. Maximum Nullifire FR230 seal size 1100 x 1100 mm.

Construction details:

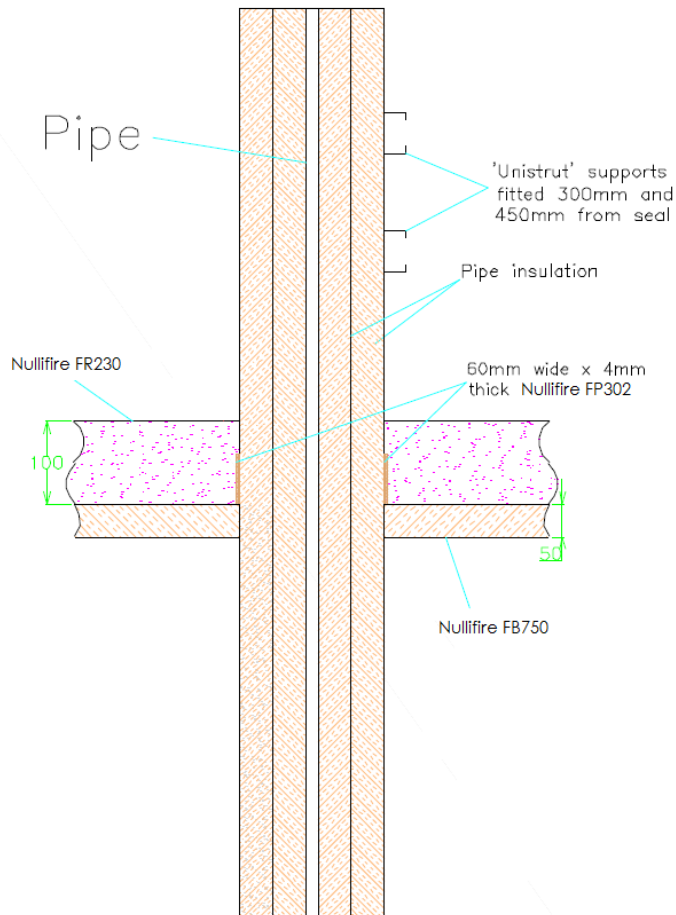

A.1.5.1

Services	Aperture in seal mm	Aperture fill mm	Nullifire FP302 wrap size mm	Classification
Copper or steel pipe 15 mm \varnothing / 0.7-14.2 mm wall, insulated with 2no. layers foil faced 48kg/m ³ glass mineral wool 60 mm thick	135 \varnothing	100 deep Nullifire FR230	1 layer of 60 x 4 fitted above the Nullifire FB750 shutterbatt in the Nullifire FR230 around the pipe insulation	EI 240 C/U

C/U = Capped/Uncapped, U/C = (Uncapped/Capped) and C/C = (capped/capped) are also covered

A.1.6 Metallic pipe penetration, seal with 100 mm thick Nullifire FR230 comprising 50mm thick Nullifire FB750 in a 150 mm thick rigid floor construction.

Penetration Seal: Metallic pipes with Paroc Icerock Ductwrap 40 mm thick x 250 mm long, butted up to the fire seal on the unexposed face, fitted at any position within the aperture (min. 60 mm to edge of seal and between services), seal fitted flush to the upper surface of the floor. Maximum Nullifire FR230 seal size 1100 x 1100 mm.

Construction details:

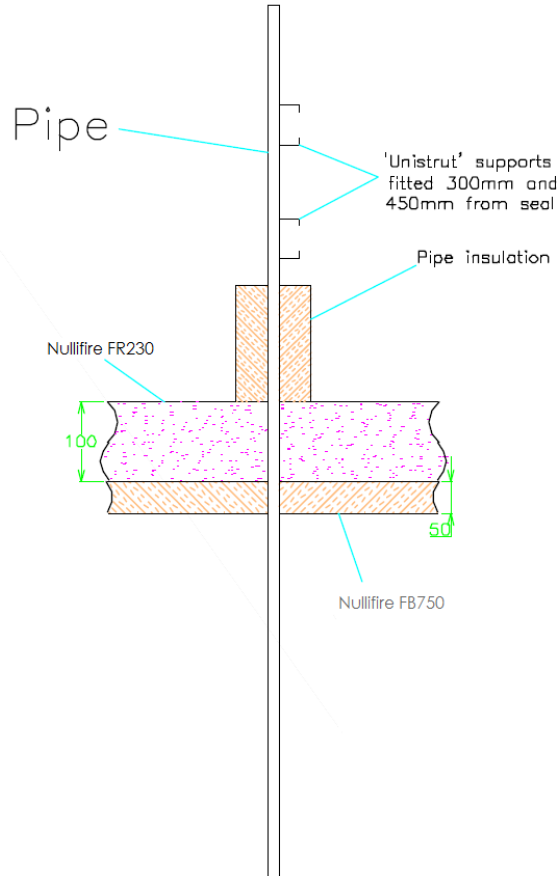

A.1.6.1

Services	Aperture in seal mm	Aperture fill mm	Nullifire FP302 wrap size mm	Classification
Copper or steel pipe 15 mm \varnothing / 0.7-14.2 mm wall, insulated with 40mm thick Paroc Icerock Ductwrap	15 \varnothing	100 deep Nullifire FR230	N/A	EI 240 C/U

C/U = Capped/Uncapped, U/C = (Uncapped/Capped) and C/C = (capped/capped) are also covered

A.1.7 Cables penetrating through 100 mm thick Nullifire FR230 comprising 50mm thick Nullifire FB750 in a 150 mm thick rigid floor construction.

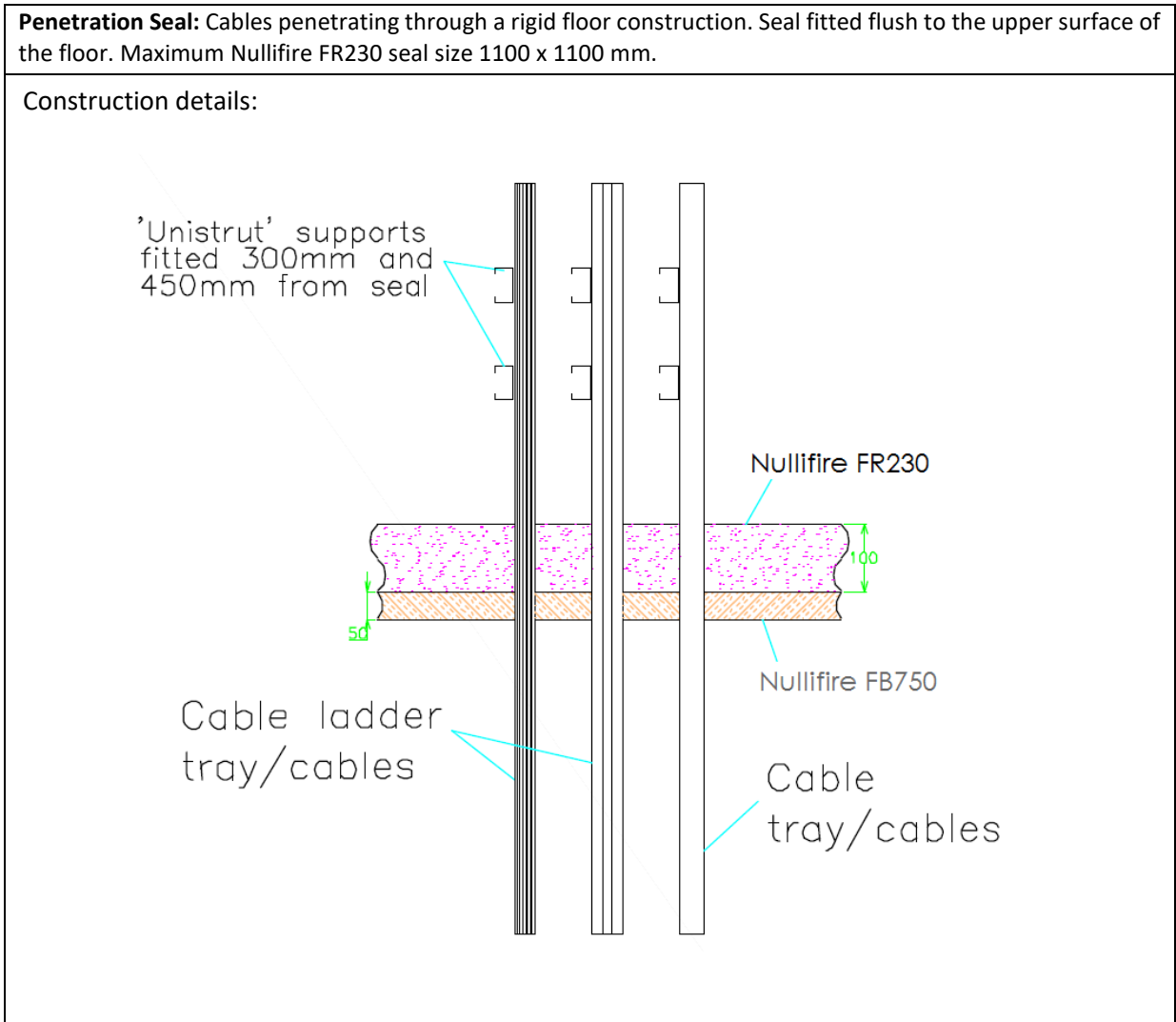

A.1.7.1

Services	Aperture fill mm	Classification
Electrical cables up to 21 mm \varnothing (single, bundled and on steel trays/ladders up to 500 mm wide)	100mm thick Nullifire FR230 fully filling the void around the cable ladder tray and cables	E 240 EI 60
Telecom cable up to 21mm \varnothing in tied bundles up to 100mm \varnothing		EI 120
Unsheathed wires up to 24 mm diameter		E 240 EI 90
Electrical cables up to 22-50 mm \varnothing (single, bundled and on steel trays/ladders up to 500 mm wide)		E 180 EI 60
Electrical cables up to 51-80 mm \varnothing (single, bundled and on steel trays/ladders up to 500 mm wide)		E 120 EI 60

A.2 Rigid wall construction with minimum thickness 150 mm.

A.2.1 Metallic pipe penetration seal with 100 mm thick Nullifire FR230 in a 150 mm thick lightweight rigid wall supporting construction

Penetration Seal: Metallic pipes with Paroc Icerock Ductwrap 40 mm thick continuous, interrupted insulation (CI), fitted at any position within the aperture (min. 60 mm to edge of seal and between services), seal fitted flush to the unexposed face of the wall. Maximum Nullifire FR230 seal size 1200 x 1200 mm.

Construction details:

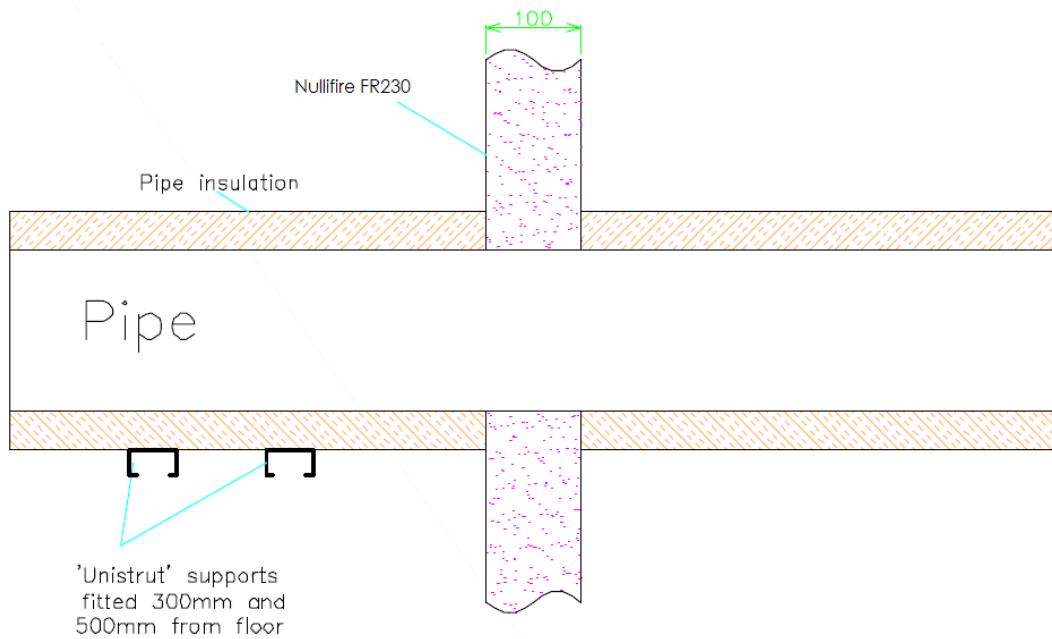

A.2.1.1

Services	Aperture in seal mm	Aperture fill mm	Nullifire FP302 wrap size mm	Classification
Steel pipe 170 mm \varnothing / 7.0-14.2 mm wall, insulated with 40mm thick Paroc Icerock Ductwrap	170 \varnothing	100 deep Nullifire FR230	N/A	E 240, EI 180 C/U
Steel pipe 150 mm \varnothing / 3.0-14.2 mm wall, insulated with 40mm thick Paroc Icerock Ductwrap	150 \varnothing			E 240, EI 120 C/U
Copper or steel pipe 108 mm \varnothing / 1.5-14.2 mm wall, insulated with 40mm thick Paroc Icerock Ductwrap	108 \varnothing			E 240, EI 60 C/U
Steel pipe 40 mm \varnothing / 1.5-14.2 mm wall, insulated with 40mm thick Paroc Icerock Ductwrap	40 \varnothing			E 240, EI 120 C/U
Copper or steel pipe 115 mm \varnothing / 0.7-14.2 mm wall, insulated with 40mm thick Paroc Icerock Ductwrap	15 \varnothing			E 240, EI 180 C/U

C/U = Capped/Uncapped, U/C = (Uncapped/Capped) and C/C = (capped/capped) are also covered

A.2.2 Metallic pipe penetration seal with 100 mm thick Nullifire FR230 in a 150 mm thick lightweight rigid wall supporting construction.

Penetration Seal: Metallic pipes with 2no. layers foil faced 48kg/m³ glass mineral wool 60 mm thick continuous, sustained insulation (CS), fitted at any position within the aperture (min. 60 mm to edge of seal and between services), seal fitted flush to the unexposed face of the wall. Maximum Nullifire FR230 seal size 1200 x 1200 mm.

Construction details:

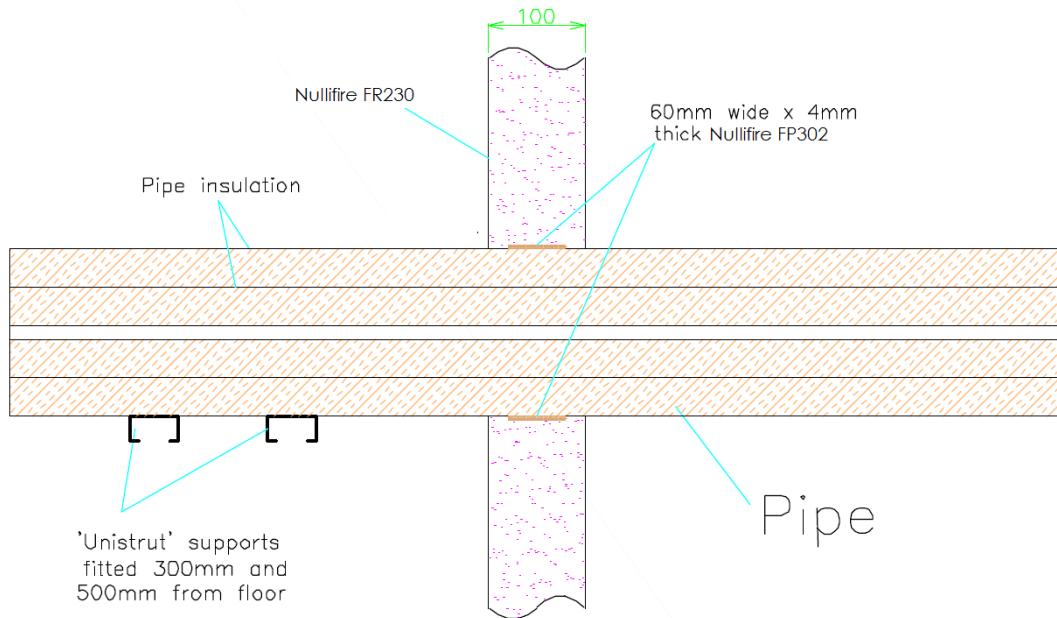

A.2.2.1

Services	Aperture in seal mm	Aperture fill mm	Nullifire FP302 wrap size mm	Classification
Copper or steel pipe 15 mm \varnothing / 0.7-14.2 mm wall, insulated with 2no. layers foil faced 48kg/m ³ glass mineral wool 60 mm thick	135 \varnothing	100 deep Nullifire FR230	1 layer of 60 x 4 fitted centrally in the Nullifire FR230 around the pipe insulation	E 240, EI 180 C/U

C/U = Capped/Uncapped, U/C = (Uncapped/Capped) and C/C = (capped/capped) are also covered

A.2.3 Metallic pipe penetration seal with 100 mm thick Nullifire FR230 in a 150 mm thick lightweight rigid wall supporting construction.

Penetration Seal: Metallic pipes with 2no. layers Beta Plus Phenolic foam 60 mm thick continuous, sustained insulation (CS), fitted at any position within the aperture (min. 60 mm to edge of seal and between services), seal fitted flush to the unexposed face of the wall. Maximum Nullifire FR230 seal size 1200 x 1200 mm.

Construction details:

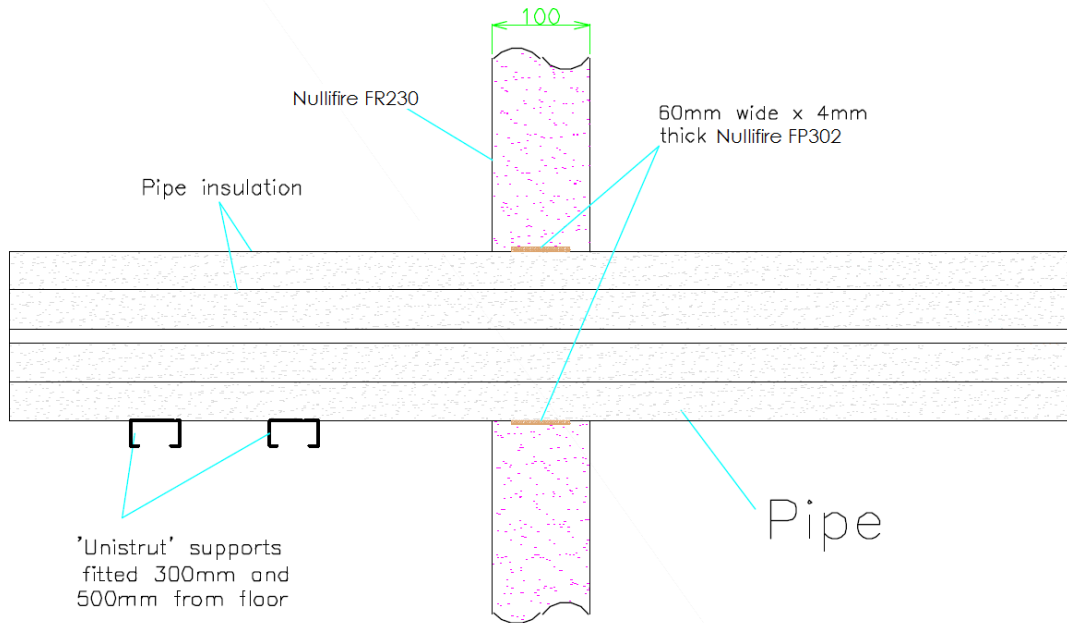

A.2.3.1

Services	Aperture in seal mm	Aperture fill mm	Nullifire FP302 wrap size mm	Classification
Copper or steel pipe 15 mm \varnothing / 0.7-14.2 mm wall, insulated with 2no. layers Beta Plus Phenolic foam 60 mm thick	135 \varnothing	100 deep Nullifire FR230	1 layer of 60 x 4 fitted centrally in the Nullifire FR230 around the pipe insulation	EI 240 C/U

C/U = Capped/Uncapped, U/C = (Uncapped/Capped) and C/C = (capped/capped) are also covered

A.2.4 Metallic pipe penetration seal with 100 mm thick Nullifire FR230 in a 150 mm thick lightweight rigid wall supporting construction.

Penetration Seal: Metallic pipes with Paroc Icerock Ductwrap 40 mm thick x 200 mm long local, interrupted insulation (LI), fitted at any position within the aperture (min. 60 mm to edge of seal and between services), seal fitted flush to the unexposed face of the wall. Maximum Nullifire FR230 seal size 1200 x 1200 mm.

Construction details:

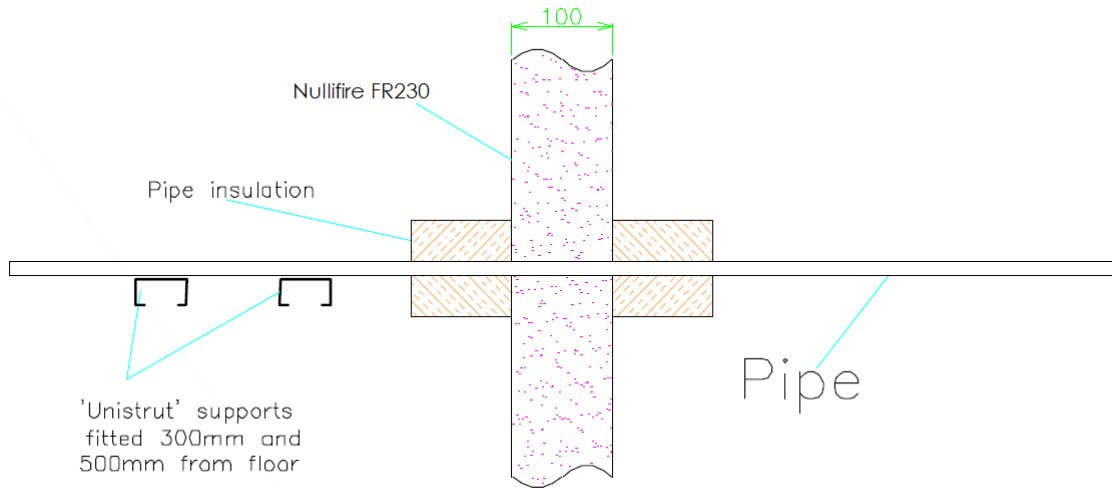

A.2.4.1

Services	Aperture in seal mm	Aperture fill mm	Nullifire FP302 wrap size mm	Classification
Copper or steel pipe 15 mm \varnothing / 0.7-14.2 mm wall, insulated with 40mm thick Paroc Icerock Ductwrap	15 \varnothing	100 deep Nullifire FR230	N/A	E 240, EI 60 C/U

C/U = Capped/Uncapped, U/C = (Uncapped/Capped) and C/C = (capped/capped) are also covered

A.2.5 Cables penetrating through 100 mm thick Nullifire FR230 in a 150 mm thick lightweight rigid wall supporting construction.

Penetration Seal: Cables penetrating through a lightweight rigid wall construction. Seal fitted flush to the unexposed face of the wall. Maximum Nullifire FR230 seal size 1200 x 1200 mm.

Construction details:

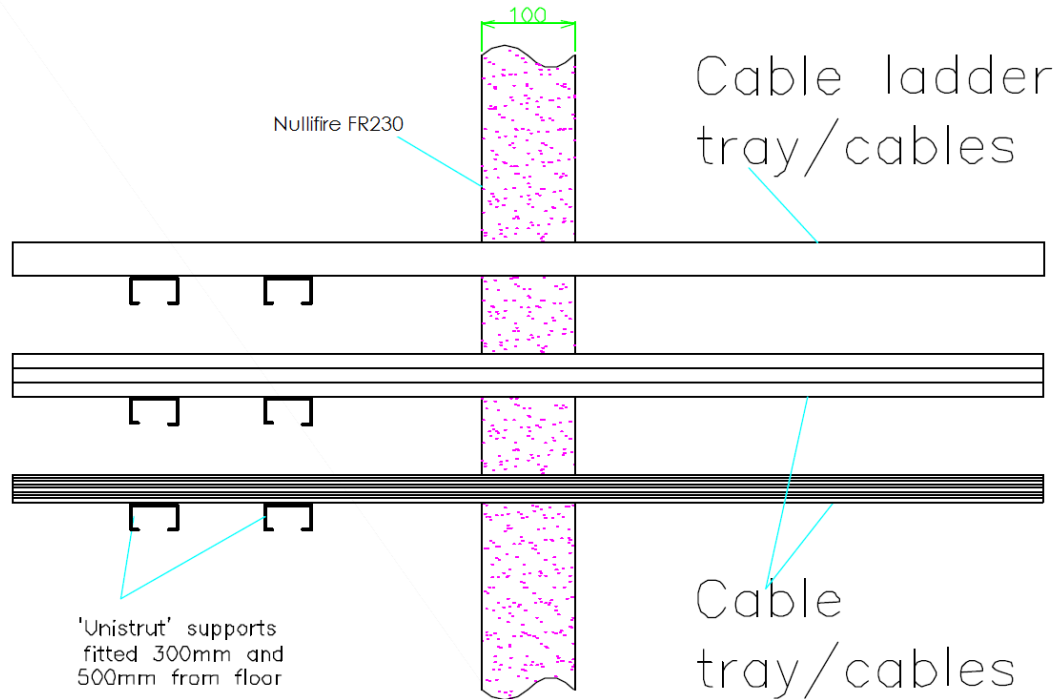

A.2.5.1

Services	Aperture fill mm	Classification
Electrical cables up to 21 mm \varnothing (single, bundled and on steel trays/ladders up to 500 mm wide)	100mm thick Nullifire FR230 fully filling the void around the cable ladder tray and cables	E 180 EI 60
Telecom cable up to 21mm \varnothing in tied bundles up to 100mm \varnothing		EI 90
Unsheathed wires up to 24 mm diameter		E 240 EI 45
Electrical cables up to 22-80 mm \varnothing (single, bundled and on steel trays/ladders up to 500 mm wide)		E 120 EI 60

ANNEX B – Mechanical resistance and stability, Resistance to impact/movement and Adhesion – Nullifire FR230

B.1 Nullifire FR230 with minimum depth 100 mm

B.1.1 Hard Body Impact Serviceability Results

Test	Drop	Indent (mm)	
		Depth	Diameter
1	1	-	23.68
	2	-	29.81
	3	5.15	34.84
2	1	-	23.32
	2	-	25.8
	3	4.73	38.71
3	1	-	22.85
	2	-	30.81
	3	5.33	34.3

After each drop there was no sign of penetration or degradation. The only visible damage was a localised indentation as recorded in Table 1.

Tested at 1500 mm by 1000 mm

B.2 Nullifire FR230 with minimum depth 100 mm

B.2.1 Hard Body Impact Safety In Use Results

Position	Indent (mm)	
	Depth	Diameter
1	3.63	26.92
2	3.35	29.34
3	3.79	28.72

Hard body safety in use impact tests was performed in three locations on the floor, in each point there was no sign of collapse, penetration or projection after the drop. The only visible damage was a localised indentation as recorded in Table 2.

Tested at 1500 mm by 1000 mm

B.3 Nullifire FR230 with minimum depth 100 mm

B.3.1 Soft Body Impact Results

Table 3			
Position	Drop	drop	Visible
Serviceability	Height		Damage
1	245	1	No damage
		2	No damage
		3	No damage
2	489	1	No damage
		2	No damage
		3	No damage
3	1019	1	No damage
		2	No damage
		3	No damage
Safety			
3	1427	1	No damage

Soft body impact tests were performed in three locations on the floor, in each point there was no sign of collapse, penetration or projection after the drops.

A safety in use drop of 1427mm was performed at Point III, the deflection after this drop could not be recorded due to equipment malfunction however, there was no sign of damage or deflection of the panel after testing.

Tested at 1500 mm by 1000 mm

B.4 Nullifire FR230 with minimum depth 100 mm**B.4.1 Concentrated Load and Deflection Results**

Table 4		
Load area	580mm x 480mm plywood	
Load (kN)	Deflection (mm)	Deflection after 1 min (mm)
2	0.28	0.32
5	0.92	1.01
10.3	2.24	2.46
580mm x 480mm plywood – repeat test		
Load area	580mm x 480mm plywood – repeat test	
2.2	0.25	0.28
5.15	0.73	0.8
10.22	1.57	1.75
135mm x 90mm steel plate		
Load area	135mm x 90mm steel plate	
2.08	0.24	0.27
5.1	0.8	0.89
10.01	Failure occurred	-

The results of the concentration load test are summarized in Table 4. No damage was sustained when the load was applied through a 580mm x 480mm plywood spreader plate, however failure did occur at 10kN when the load was applied through a smaller steel plate measuring 135mm x 90mm.

Tested at 1500 mm by 1000 mm